





























利滿地針位組

YAO HAN INDUSTRIES CO.,LTD.

GAUGE SET FOR "RIMOLDI" MACHINES

GAUGE SET	627-00-1CD-	627-01-1CD-	627-29-1CD-	627-00-1CD-	627-01-1CD-	627-00-1CD-	627-00-1MD-
	01-4.1 01-4.6 01-5 01-6	02-4.1 02-4.6 02-5 02-6	02-4.1 02-4.6 02-5 02-6	07-3.3 07-5	04-3.3 04-5	21 30	33
Throat Plate	 202504-0-10 202148-0-10 202507-0-10 202590-0-10			 203214-0-10 203218-0-11		 203035-0-10	
Diff Feed Dog	 202053-0-10			 203199-0-10		 203028-0-10	
Main Feed Dog asm.	 202057-0-10			 203031-0-10			
Chain Feed Dog asm.	 202061-0-10			 203004-0-10			
Presser foot asm.	202171-3-11	202178-3-11	202176-3-11	202171-3-11	202178-3-11	208365-3-11 207076-3-11	203017-3-11

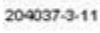













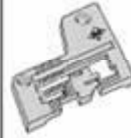











GAUGE SET FOR "RIMOLDI" MACHINES

GAUGE SET	627-00-1CD-	627-01-1CD-		627-00-2CD-	627-01-2CD-	627-00-2CD-	629-00-2CD-	
	31 (627-38-1CD-01)	05	09	17 (627-00-2MD-20) (627-00-2MD-21)	05 (627-01-2MD-07)	32	05	
Throat Plate	 203219-0-11			 204026-0-10		 203549-0-10		 204864-0-10
Diff Feed Dog	 203199-0-10			 206298-0-10		 203532-0-10		 204846-0-10
Main Feed Dog asm.	 202057-0-10			 203609-0-10		 203539-0-10		 204850-0-10
Chain Feed Dog asm.	 202609-0-10			 203612-0-10		 203544-0-10		 202609-0-10
Presser foot asm.	 203162-3-11			 204037-3-11		 204950-3-12		
	203162-3-11	202178-3-11	205892-3-00	204037-3-11	204028-3-11	203556-3-11	204950-3-12	

利滿地針位組

YAO HAN INDUSTRIES CO.,LTD.

















GAUGE SET FOR "RIMOLDI" MACHINES

GAUGE SET	629-00-2CD-		629-00-2MD-	629-22-2MD-	629-GA1	629-GA2	629-GA3
	06 (629-00-2MD-06)	10 (629-00-2MD-10)	13	04			
Throat Plate	 205025-0-10		 208048-0-10		 204668-0-10	 204867-0-10	 205026-0-10
Diff Feed Dog	 205007-0-10	 205060-0-10	 208051-0-10		 204667-0-10	 204848-0-10	 205010-0-10
Main Feed Dog asm.	 205011-0-10	 205065-0-10	 208052-0-10		 204669-0-10	 204852-0-10	 205014-0-10
Chain Feed Dog asm.	 202609-0-10				 204819-0-10	 202609-0-10	
Presser foot asm.	 205070-3-12	 205118-3-12	 205070-3-12	 205034-3-12	 204706-3-12	 204875-3-12	 205034-3-12

利滿地

YAO HAN INDUSTRIES CO.,LTD.

PARTS FOR RIMOLDI 27,327,329,527,529,627,629

 <p>1. 202267-2-13 THREAD GUIDE 2. 746800-2-00 SCREW</p>	 <p>202227-0-10 TENSION SPRING,M</p>	 <p>202228-0-10 TENSION SPRING,H</p>	 <p>202681-0-10 TENSION SPRING,L</p>	 <p>202279-0-10 THREAD TAKE-UP</p>
 <p>202683-0-10 THREAD TAKE-UP</p>	 <p>202284-0-10 THREAD TAKE-UP</p>	 <p>202228-0-10 THREAD SPRING,H</p>	 <p>202681-0-10 TENSION SPRING,L</p>	 <p>202279-0-10 THREAD TAKE-UP</p>
 <p>204690-0-10 202683-0-10 THREAD TAKE-UP</p>	 <p>205024-0-10 202284-0-10 THREAD TAKE-UP</p>	 <p>202256-0-10 THREAD GUIDE</p>	 <p>202658-0-10 (272-186) ANGLE STOP</p>	 <p>204891-0-10 SPRING</p>
 <p>204690-0-10 NEEDLE PLATE SCREW</p>	 <p>205024-0-10 DIFF FEED DOO SCREW</p>	 <p>MAIN FEED DOO SCREW</p>	 <p>204878-0-11 BRACKET ASM.</p>	 <p>BRACKET</p>
 <p>1. 205469-0-00 SHEET 2. 741675-2-00 SCREW</p>	 <p>207506-4-00 SLIDE ASM.</p>	 <p>202957-2-10 (PM275B-403) GUIDE</p>	 <p>204699-0-10 (290-115) COVER</p>	 <p>204691-0-10 (290-111) GUARD FOR UPPER KNIFE</p>

利滿地

YAO HAN INDUSTRIES CO.,LTD.

























PARTS FOR RIMOLDI 27,327,329,527,529,627,629

 202142-0-10 (270-112) UPPER KNIFE	 202143-0-10 (270-112/1) UPPER KNIFE	 202932-0-10 (276B-112) UPPER KNIFE	 203010-0-10 (277-112) UPPER KNIFE	 203066-0-10 (279-112) UPPER KNIFE
 207000-2-00 (CT270-112) UPPER KNIFE,CARBIDE	 CT270-112/1 UPPER KNIFE,CARBIDE	 207001-2-00 (CT276B-112) UPPER KNIFE,CARBIDE	 207002-2-00 (CT277-112) UPPER KNIFE,CARBIDE	 207006-2-00 (CT279-112) UPPER KNIFE,CARBIDE
 203759-0-10 (2777-112) UPPER KNIFE	 203783-0-10 (2777-1121) (290-112) UPPER KNIFE	 202146-0-10 (270-113/1) LOWER KNIFE	 203012-0-10 (277-113) LOWER KNIFE	 203069-0-10 (279-113/1) LOWER KNIFE
 207004-2-00 (CT2777-112) UPPER KNIFE,CARBIDE	 207003-2-00 (CT2777-1121) (CT290-112) UPPER KNIFE,CARBIDE	 207015-2-00 (CT270-113/1) LOWER KNIFE,CARBIDE	 207016-2-00 (CT277-113) LOWER KNIFE,CARBIDE	 207017-2-00 (CT279-113/1) LOWER KNIFE,CARBIDE
 203144-0-10 (2701P9-113/1) LOWER KNIFE	 204093-0-10 (290-113) LOWER KNIFE	 204093-0-11 (290-113SP) LOWER KNIFE	 202145-0-10 (270-113) LOWER KNIFE	
 207024-2-00 (CT2701P9-113/1) LOWER KNIFE,CARBIDE	 207020-2-00 (CT290-113) LOWER KNIFE,CARBIDE	 CT290-113SP LOWER KNIFE,CARBIDE	 202194-0-10 CHAIN CUTTER	 202194-0-11 CHAIN CUTTER

利滿地

YAO HAN INDUSTRIES CO.,LTD.























PARTS FOR RIMOLDI 27,327,329,527,529,627,629

 <p>202090-0-10 (270-074) UPPER LOOPER</p>	 <p>202091-0-10 (270-074/1) UPPER SPREADER</p>	 <p>202092-0-10 (2700-074/1) (297-074/1) UPPER SPREADER</p>	 <p>202093-0-10 (270-074/2) UPPER LOOPER</p>	 <p>(277-074) UPPER LOOPER</p>
 <p>(2777-074) UPPER LOOPER</p>	 <p>(27277-074) UPPER LOOPER</p>	 <p>(27277-074/2) UPPER LOOPER</p>	 <p>(27277-074/5) UPPER LOOPER</p>	
 <p>202094-0-11 (270-075) LOWER LOOPER</p>	 <p>202095-0-11 (270-075/2) LOWER LOOPER</p>	 <p>202413-0-11 (270-075/1) LOWER LOOPER</p>	 <p>204675-0-11 (290-075/1) LOWER LOOPER</p>	 <p>204676-0-11 (290-075/2) LOWER LOOPER</p>
 <p>209213-0-00 UPPER LOOPER</p>	 <p>209245-0-00 UPPER SPREADER</p>	 <p>209247-0-00 UPPER SPREADER</p>	 <p>209248-0-00 UPPER LOOPER</p>	 <p>209249-0-00 UPPER LOOPER</p>
 <p>207722-0-10 SAFE STITCH LOOPER</p>	 <p>209264-0-00 LOWER LOOPER</p>	 <p>209265-0-00 LOWER LOOPER</p>	 <p>209266-0-00 LOWER LOOPER</p>	 <p>209267-0-00 LOWER LOOPER</p>

利滿地針位組

YAO HAN INDUSTRIES CO.,LTD.

GAUGE SET FOR "RIMOLDI" MACHINES

GAUGE SET	263-06-3MD-	263-10-3MD-	263-16-2MD-	263-17-2MD-	263-17-3MD-	263-34-2DR-	263-34-3DR-
	02 (360)	15-350 (350) 15-360 (360)	18 (245)	01-GA1 (235) 01-GA2 (235)	07 (360)	22 (230) 20 (235) 27 (245)	16 (360)
Throat Plate	 302408-2-10	 302467-0-10 302416-0-10	 301765-0-10	 301759-0-10 301760-0-10	 301764-0-10	 302754-0-10 302811-0-10 302810-0-10	 302735-0-10
Diff Feed Dog	 300576-0-11 300564-0-12	 300104-0-11	 300104-0-11 301755-0-10	 300135-0-10	 302798-0-10 302799-0-10 302797-0-10	 302797-0-10	
Main Feed Dog asm.	 300563-0-12	 300102-0-10	 300133-0-10	 302796-0-10 302799-0-10 302795-0-10	 302795-0-10		
Presser foot asm.	 300583-3-12 302457-3-13 300581-3-13	 300145-0-10 300110-3-11	 300111-3-11	 304407-3-11 304407-3-11 304489-3-11	 304406-0-10		

利滿地

YAO HAN INDUSTRIES CO.,LTD.

PARTS FOR RIMOLDI 261,263,264

 <p>302172-0-10 THREAD GUIDE</p>	 <p>SCREW 744730-2-00 NEEDLE PLATE SCREW</p>	 <p>SCREW 745600-2-00 NEEDLE CLAMP SCREW</p>	 <p>302808-0-10 (6378-113) LOWER KNIFE</p>	 <p>1. 302807-0-10 (6378-112) UPPER KNIFE 2. 741642-2-00 SCREW</p>
 <p>CT302865-0-11 UPPER KNIFE, CARBIDE</p>	 <p>308080-0-10 SPREADER</p>	 <p>302056-4-10 (6633-075/1) LOOPER</p>	 <p>302055-0-10 (633-075/1) LOOPER</p>	 <p>1. 302063-0-10 NEEDLE GUARD 2. 203197-0-10 SCREW</p>
 <p>302057-0-13 LOOPER</p>	 <p>303419-0-12 LOOPER</p>	 <p>312057-0-00 LOOPER</p>	 <p>304186-0-13 LOWER LOOPER</p>	 <p>304187-0-10 RETAINER LOOPER</p>
 <p>1. TWE6 TWEEZER 2. TWE7 TWEEZER</p>	 <p>1. 9904740-11 NEEDLE SET SCREW WRENCH 2. 9904740-11P NEEDLE SET SCREW WRENCH</p>	 <p>990982-0-00 MOUNTING ISOATOR</p>		
 <p>THREADING WIRE</p>	 <p>990019-0-10 PLASTIC OILER</p>	 <p>990296-2-10 (270-004) MOUNTING ISOATOR</p>		