

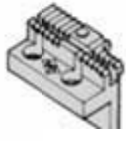







精工針位組

YAO HAN INDUSTRIES CO.,LTD.









GAUGE SET FOR "SEIKO" MACHINES





GAUGE SET		Throat Plate	Feed Dog	Presser foot asm.		
						
LSW-7L		10863				
STW-7		10863	10482	11202		
			10482A	11202A		
			10483	11203-SK		
			10484-SK	10024		
			10485	11204-SK		
			10485A	11204A		
			10486-SK	11205		
GAUGE SET	Needle gauge size		Throat Plate	Fe-484-SK	10024	10484
						
	inch	mm				
LSW-27L	1/8"	3.2	16422	10482	11202	10482
	5/32"	4.0	16422A	10482A	11202A	10482A
	3/16"	4.8	16423	10483	11203-SK	10483
	7/32"	5.6	16424	10484-SK	10024	10484
	1/4"	6.4	16425	10485	11204-SK	10485
	9/32"	7.1	16425A	10485A	11204A	10485A
	5/16"	7.9	16426	10486-SK	11205	10486
	3/8"	9.5	16427	10487	11206	10487
	7/16"	11.1	16428	10488	10028-SK	10488
	1/2"	12.7	16429	10489	10029-SK	10489
	9/16"	14.3	16430	10490	10030	10470
	5/8"	15.9	16431	10491	10031-SK	10471
	11/16"	17.5	16431A	10491A	10031A	10471A
	3/4"	19.1	16432	10492	10032	10472
	7/8"	22.2	16433	10493	10033	10473
	1"	25.4	16434	10494	10034	10474
	1-1/8"	28.6	16434A	10494A	10034A	10474A
	1-1/4"	31.8	16435	10495	10035-SK	10475
	1-3/8"	34.9	16435A	10495A	10035A	10475A
	1-1/2"	38.1	16436	10496	10036	10476
1-5/8"	41.3	16436A	10496A	10036A	10476A	
1-3/4"	44.5	16436B	10496B	10036B	10476B	

精工針位組

YAO HAN INDUSTRIES CO.,LTD.

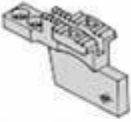
GAUGE SET FOR "SEIKO" MACHINES

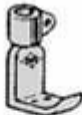



GAUGE SET	Throat Plate	Feed Dog	Presser foot asm. (Inside)	Presser foot asm. (Outside)
LSW-8L	 10665	 10805	 10795	 10796
LSW-8L-T	 15150	 15153	 15155	 15154





GAUGE SET	Needle gauge size		Throat Plate	Feed Dog	Needle Clamp asm.	Presser foot asm. (Inside)	Presser foot asm. (Outside)
	inch	mm					
LSW-26L	1/8"	3.2					
	5/32"	4.0	16422A	10482A	10002A	10282A	10182A
	3/16"	4.8	16423	10483	10003-SK	10283	10183
	7/32"	5.6	16424	10484-SK	10004-SK	10284	10184
	1/4"	6.4	16425	10485	10005-SK	10285	10185-SK
	9/32"	7.1	16425A	10485A	10005A	10285A	10185A
	5/16"	7.9	16426	10486-SK	10006	10286	10186-SK
	3/8"	9.5	16427	10487	10007-SK	10287	10187-SK
	7/16"	11.1	16428	10488	10008-SK	10288	10188-SK
	1/2"	12.7	16429	10489	10009-SK	10289	10189-SK
	9/16"	14.3	16430	10490	10010	10290	10190-SK
	5/8"	15.9	16431	10491	10011-SK	10291	10191
	11/16"	17.5	16431A	10491A	10011A	10291A	10191A
	3/4"	19.1	16432	10492	10012	10292	10192
	7/8"	22.2	16433	10493	10013	10293	10193
	1"	25.4	16434	10494	10014-SK	10294	10194
	1-1/8"	28.6	16434A	10494A	10014A	10294A	10194A
	1-1/4"	31.8	16435	10495	10015-SK	10295	10195
	1-3/8"	34.9	16435A	10495A	10015A	10295A	10195A
	1-1/2"	38.1	16436	10496	10016-SK	10296	10196
1-5/8"	41.3	16436A	10496A	10016A	10296A	10196A	
1-3/4"	44.5	16436B	10496B	10016B	10296B	10196B	





精工針位組

YAO HAN INDUSTRIES CO.,LTD.





GAUGE SET FOR "SEIKO" MACHINES

GAUGE SET	Throat Plate	Feed Dog
PW-6-A	 12003	 12006
PW-6-B	 12003-4	 12006-4

GAUGE SET	Throat Plate	Feed Dog
PW-6-C	 12003-S	 12006-S
PW-6-D	 12020	 12021

GAUGE SET	Throat Plate	Feed Dog
PW-26 1/16"	 12060	 12057
PW-26 3/32"	 12062	 12064

We are a manufacturer and exporter, easily produce new parts for you, Please send samples to us, and we can make it for immediately.

GAUGE SET	Needle gauge size		Throat Plate	Feed Dog	Needle Clamp asm.	Presser foot asm.
	inch	mm				
PW-26	1/8"	3.2	10352	10382	10102	10312
	5/32"	4.0	10352A	10382A	10102A	10312A
	3/16"	4.8	10353	10383	10103	10313
	7/32"	5.6	10354	10384	10104	10314
	1/4"	6.4	10355	10385	10105	10315
	9/32"	7.1	10355A	10385A	10105A	10315A
	5/16"	7.9	10356	10386	10106	10316
	3/8"	9.5	10357	10387	10107	10317
	7/16"	11.1	10358	10388	10108	10318
	1/2"	12.7	10359	10389	10109-SK	10319
	5/8"	15.9	10359A	10389A	10111-SK	10319A
	3/4"	19.1	10359B	10389B	10112-SK	10319B





精工針位組

YAO HAN INDUSTRIES CO.,LTD.

GAUGE SET FOR "SEIKO" MACHINES

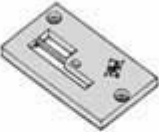
GAUGE SET	Needle gauge size		Throat Plate	Feed Dog	Needle Clamp asm.	Presser foot asm.
	inch	mm				
PW-27	3/32"	2.4	10361	10391	12066	10321
	1/8"	3.2	12211	12221	10102	10322
	5/32"	4.0	12211A	12221A	10102A	10322A
	3/16"	4.8	12213	12223	10103	10323
	1/4"	6.4	12216	12226	10105	10325
	5/16"	7.9	10366	10396	10106	10326
	3/8"	9.5	10367	10397	10107	10327





















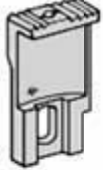

GAUGE SET	Needle gauge size		Throat Plate	Feed Dog	Needle Clamp asm.	Presser foot asm. (Inside)	Presser foot asm. (Outside)
	inch	mm					
PW-26	1/8"	3.2	12211	12221	10122	10282	10332
	5/32"	4.0	12211A	12221A	10122A	10282A	10332A
	3/16"	4.8	12213	12223	10123-SK	10283	10333
	1/4"	6.4	12216	12226	10125-SK	10285	10335
	5/16"	7.9	10366	10396	10126	10286	10336
	3/8"	9.5	10367	10397	10127	10287	10337

GAUGE SET	Throat Plate	Feed Dog	Needle Clamp asm.	Presser foot asm. (Inside)	Presser foot asm. (Outside)
SK-6F	 1380-CN	 1376	 1320	 1403	 1408

精工針位組

YAO HAN INDUSTRIES CO.,LTD.





GAUGE SET FOR "SEIKO" MACHINES









GAUGE SET	Throat Plate	Feed Dog	Presser foot asm. (Inside)	Presser foot asm. (Outside)
CW-7B	 13104	 13103	 13105	-----
CW-8B	 13022	 13020	 10795	 10796
CW-8V	 13240	 13243	 13249	 13246
LCW-8BL	 13709	 13708	 10795	 10796
STH-8BLD	 18030	 18031	 10795	 10796
STH-8BLD-OP	 18030-L	 18031-L	 10795L	 10796L





精工針位組

YAO HAN INDUSTRIES CO.,LTD.

GAUGE SET FOR "SEIKO" MACHINES

GAUGE SET	Throat Plate	Feed Dog	Presser foot asm. (Inside)	Presser foot asm. (Outside)
CH-8B	 28121	 28119	 28137	 28057

Presser foot asm. (Inside)	Presser foot asm. (Outside)	Presser foot asm. (Inside)	Presser foot asm. (Outside)
 10795K 1/8\" 10795K 3/16\" 10795K 1/4\" 10795K 5/16\"	 10796K 1/8\" 10796K 3/16\" 10796K 1/4\" 10796K 5/16\"	 10795K 1/8\" 10795K 3/16\" 10795K 1/4\" 10795K 5/16\"	 10796K 1/8\" 10796K 3/16\" 10796K 1/4\" 10796K 5/16\"
 10795P 1/4\"	 10796P 1/4\"	 10795D 1/8\"	 10796D 1/8\"

Throat Plate	Feed Dog	Throat Plate	Feed Dog
 17089	 17073	 17113	 17105

精工

YAO HAN INDUSTRIES CO.,LTD.

PARTS FOR SEIKO CW-8B

 <p>1. 10530 NEEDLE BAR COMPLETE 2. 10533 THREAD GUIDE 3. 10534 SCREW 4. 10535 SCREW</p>	 <p>1. 10540 PRESSER BAR 2. 10664 SCREW</p>	 <p>10546 TENSION RELEASE SLIDE</p>	 <p>10656 BOBBIN</p>	 <p>13042 HOOK WASHER</p>
 <p>13035 HOOK SADDLE</p>	 <p>13034 HOOK BEVEL GEAR</p>	 <p>13032 HOOK BEVEL FINION GEAR</p>	 <p>10621 ARM SHAFT CONNECTING BELT</p>	 <p>10659 PRESSER BAR LIFTER</p>
 <p>13016A FEED BAR COMPLETE</p>	 <p>13016 FEED BAR</p>	 <p>13019 FEED LIFTING FORK</p>	 <p>13030 FEED LIFTING ECCENTRIC</p>	 <p>1. 13023 NEEDLE PLATE SCREW 2. 10561 FEED DOG SCREW</p>
 <p>10675A TENSION COMPLETE</p>	 <p>10694 THREAD CONTROLLER DISC</p>	 <p>10689 CHECK SPRING FOR LTW-27BL</p>	 <p>1. 10691 TENSION DISC 2. 10692 TENSION RELEASE WASHER 3. 10793 TENSION RELEASE PLUNGER 4. 10693 TENSION SPRING</p>	
 <p>15032-SK (FOR LCW-8BL) NEEDLE BAR</p>	 <p>10992 (FOR LSW-27L) 10955 (FOR LSW-28L) NEEDLE BAR</p>	 <p>10649 BOBBIN CASE OPENER FOR LTW-27BL</p>	 <p>15048 BOBBIN CASE OPENER FOR CH-8B</p>	 <p>15041-SK BOBBIN LSC-8BL</p>
		 <p>10595 FEED FORK</p>	 <p>28092 BOBBIN</p>	 <p>18034 BOBBIN</p>