





高林針位組

YAO HAN INDUSTRIES CO.,LTD.

GAUGE SET FOR "SIRUBA" MACHINES

GAUGE SET	Throat Plate	Diff Feed Dog	Main Feed Dog	Needle Clamp	Presser foot asm.
					
737-504F1-04	E784	H442	D569	KG131	P152/F155
737-504M1-15	E934	H442	D290	KG131	P152/F525
737-504M2-04	E800	H445	D575	KG131	P253/F371
737-504M2-04LFC-2	E800	H445	D575	KG131	P101/F371
737-504M3-04	E796	H445	D574	KG131	P230/F371
737-504M3-05	E797	H445	D574	KG131	P230/F371
737-504M5-04	E599	H974	D390	KG131	P975/F380
737-504M5-05	E590	H974	D390	KG131	P975/F380
737-504H4-04	E800	H959	D996	KG131	P136
737-505F1-03	E783	H442	D569	KG131	P152/F155
737-505F1-04	E784	H442	D569	KG131	P152/F155
747-512M1-24	E809	H445	D575	KG142	P253/F374
747-512M1-25	E810	H445	D575	KG142	P253/F374
747-512M8-23	E804A	H446	D576	KG142	P230/F503
747-512M8-25	E810A	H446	D577	KG142	P253/F374
747-514M2-24	E809	H445	D575	KG142	P253/F374
747-514M2-24LF-B	E809	H445	D575	KG142	P101/F374
747-514M2-25	E810	H445	D575	KG142	P253/F374
747-514M4-23	E804	H445	D574	KG142	P230/F503
747-514M4-24	E805	H445	D574	KG142	P230/F374
747-514M5-23	E591	H974	D390	KG142	P975/F381
747-514M7-23	E804A	H446	D576	KG142	P230/F503
747-514M7-24	E809A	H446	D577	KG142	P253/F374
747-514H4-24	E809	H959	D996	KG142	P136
747-514H4-25	E810	H959	D996	KG142	P136
757-516L1-24	E834	H492	D579	KG152	P500
757-516L1-35	E839	H492	D579	KG153	P501
757-516M1-55	E851	H494	D581	KG155	P502
757-516M2-35	E982	H497	D581	KG153	P504
757-516M2-55	E986	H500	D581	KG155	P502
757-516H1-55	E851	H495	D582	KG155	P502
757-516H2-56	E868	H501	D582	KG155	P502
757-516H4-35	E982	H957	D002	KG153	P508
757-516H4-55	E986	H957	D003	KG155	P509
757-516X1-55	E853	H495	D582	KG155	P955
757-516X1-56	E854	H495	D582	KG155	P955
757-516X2-56	E868	H501	D582	KG155	P955
767-516M2-324	E989	H497	D971/D502	KG333	P233
767-516M2-524	E988	H500	D972/D502	KG355	P255
747F-512M1-25	E920	H445	D575	KG142-E	P253E-4
747F-514M2-24	E919	H445	D575	KG142-E	P253E-4
747F-514M2-24LF-B	E919	H445	D575	KG142-E	P101-4
747F-514M2-24LFC-2	E919	H445	D575	KG142-E	P101-4

PARTS FOR SIRUBA 737F,747F,757F

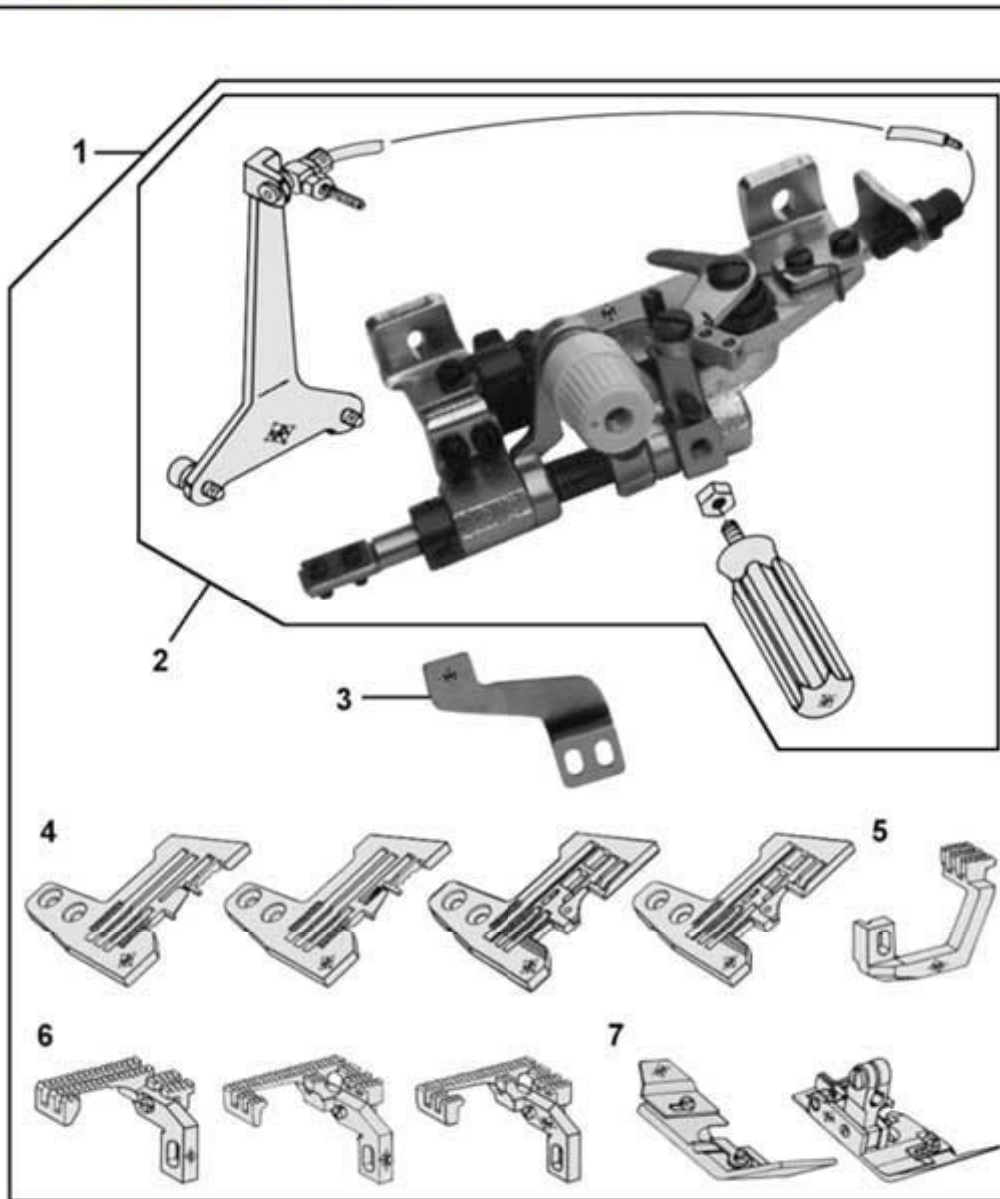

- 1. 737-GA(0X4)+R SHIRRING ATTACHMENT WITH GAUGE SET ASM.
- 747-GA(2X4)+R SHIRRING ATTACHMENT WITH GAUGE SET ASM.
- 747-GA(2X5)+R SHIRRING ATTACHMENT WITH GAUGE SET ASM.
- 757-GA(3X3)+R SHIRRING ATTACHMENT WITH GAUGE SET ASM.
- 757-GA(3X5)+R SHIRRING ATTACHMENT WITH GAUGE SET ASM.
- 757-GA(5X5)+R SHIRRING ATTACHMENT WITH GAUGE SET ASM.
- 2. GA RUFFLING ATTACHMENT ASSEMBLY

- | | | | |
|---------|---------------------|---------|-----------------------------|
| 3. KV16 | BLADE (0X4,2X4,2X5) | 5. H959 | DIFF FEED DOG (0X4,2X4,2X5) |
| KV17 | BLADE (3X3,3X5,5X5) | H957 | DIFF FEED DOG (3X3,3X5,5X5) |
| 4. E800 | NEEDLE PLATE (0X4) | 6. D996 | MAIN FEED DOG (0X4,2X4,2X5) |
| E919 | NEEDLE PLATE (2X4) | D002 | MAIN FEED DOG (3X3,3X5) |
| E920 | NEEDLE PLATE (2X5) | D003 | MAIN FEED DOG (5X5) |
| E980 | NEEDLE PLATE (3X3) | 7. P136 | PRESSER FOOT (0X4,2X4,2X5) |
| E982 | NEEDLE PLATE (3X5) | P508 | PRESSER FOOT (3X3,3X5) |
| E986 | NEEDLE PLATE (5X5) | P509 | PRESSER FOOT (5X5) |















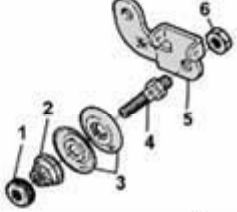
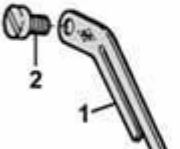

高林

YAO HAN INDUSTRIES CO.,LTD.

PARTS FOR SIRUBA 737F,747F,757F

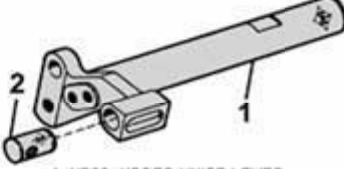
 <p>KB22F (FOR 737,747) KB23F (FOR 757) SIDE COVER</p>	 <p>1. KC09F BELT COVER 2. SK257 SCREW</p>	 <p>1. KC15 FABRIC GUARD 2. SK257 SCREW</p>	 <p>KC22B (FOR 737,747) KC23B (FOR 757) FRONT COVER</p>	 <p>1. KC21 FRONT COVER 2. KC20 LATCH 3. SM432 SCREW</p>
 <p>KC24B FRONT COVER HINGE</p>	 <p>KC28 HINGE SPRING</p>	 <p>1. KF28 CONNECTION 2. SK385 SCREW</p>	 <p>1. KF33 STUD 2. EK01 STOP RING 3. SK216 SCREW 4. KF32 NEEDLE HOLDER GUIDE 5. KF14 PIN 6. KF16 OIL WICK 7. SK204 SCREW 8. K01821A NEEDLE THREAD TENSION ASM. 9. K021 GUIDE 10. K019 SPRING 11. K017 THREAD RETAINER 12. K018 BRACKET 13. SK221 SCREW</p>	
 <p>1. KC36 HOOK SPRING 2. SK250 SCREW</p>	 <p>KC07 OIL GAUGE WINDOW</p>	 <p>K010 TENSION GUIDE</p>	 <p>FOR 737,747 K011F THREAD TAKE-UP</p>	 <p>FOR 757,767 K060F THREAD TAKE-UP</p>
 <p>1. K001 THREAD TENSION ASM. 2. K004 POST NUT 3. K005 SPRING BUSHING 4. K002 SPRING 5. K006 CUP 6. K007 TENSION DISC 7. K008 FELT 8. K003 TENSION STUD</p>	 <p>1. AK026 SUPPORT COMPLETE 2. K026 SUPPORT COMPLETE 3. SK236 GUIDE 4. SK242 SCREW</p>	 <p>1. K031D NEEDLE GUARD FRONT 2. SK209 SCREW</p>	 <p>1. K032D NEEDLE GUARD REAR 2. SK209 SCREW</p>	 <p>1. K035 NEEDLE GUARD FRONT 2. SK230 SCREW</p>
 <p>1. K0471 (FOR 737) K0472 (FOR 747) NEEDLE GUARD 2. SK230 SCREW</p>	 <p>1. K037 NEEDLE GUARD REAR 2. SK209 SCREW</p>	 <p>K042 (FOR 737,757) K054 (FOR 747,767) THREAD GUIDE</p>	 <p>1. K059 MOVABLE NEEDLE GUARD 2. W005 WASHER 3. SK243 SCREW</p>	 <p>KJ01B CONNECTION</p>
 <p>KJ01B CONNECTION</p>	 <p>KJ30F GUIDE</p>	 <p>1. KJ26 UPPER LOOPER HOLDER 2. SK229 SCREW 3. KJ27 PIN 4. KJ29 OIL WICK</p>	 <p>1. KJ22 LEVER 2. SK295 SCREW 3. SK216 SCREW</p>	 <p>1. KJ22 LEVER 2. SK295 SCREW 3. SK216 SCREW</p>



PARTS FOR SIRUBA 737F,747F,757F

 <p>1. KJ63 THREAD GUIDE 2. WK06 WASHER 3. SK223 SCREW</p>	 <p>1. KJ68 UPPER LOOPER THREAD TAKE-UP 2. SK257 SCREW</p>	 <p>KL23 LOWER LOOPER LEVER</p>	 <p>KL38 THREAD GUIDE (RIGHT)</p>	 <p>1. KL43 THREAD GUIDE (LEFT) 2. SK241 SCREW</p>
 <p>KL46 THREAD GUIDE</p>	 <p>1. KM01 CHAIN LOOPER HOLDER 2. SK298 SCREW 3. SK230 SCREW 4. KM06 REGULATOR 5. SK209 SCREW</p>	 <p>1. KN18-E LOOPER THREAD TAKE-UP 2. SK216 SCREW</p>	 <p>1. KN32 LOOPER THREAD GUIDE FRONT 2. SK250 SCREW</p>	
 <p>1. KN34 THREAD GUIDE REAR 2. SK250 SCREW</p>	 <p>1. KN44 NUT 2. KN43 TENSION SPRING 3. KN42 TENSION DISC 4. KN40 TENSION POST 5. KN38 BRACKET 6. NK26 NUT</p>	 <p>1. KN24 LOOPER THREAD GUIDE BRACKET 2. SK264 SCREW 3. KN26 WASHER 4. KN22 EYELET 5. SK207 SCREW</p>		
 <p>1. KN20 GUIDE 2. SK233 SCREW</p>	 <p>1. KN27 STOPPER 2. KN29 SPRING 3. WK09 WASHER 4. SK238 SCREW</p>	 <p>1. KQ37 CRANK COMPLETE 2. SK295 SCREW</p>	 <p>KP21 CONNECTION</p>	 <p>KP22 BEARING</p>
 <p>SK260 SCREW</p>	 <p>SK576 SCREW</p>	 <p>1. KQ05 BRACKET 2. SK245 SCREW</p>	 <p>1. SK576 SCREW 2. SK208 SCREW</p>	 <p>SK216 SCREW</p>
 <p>KQ49 FEED BAR OIL SEAL</p>	 <p>1. KR09 UPPER KNIFE LEVER 2. KR22 PIN</p>	 <p>1. KR20 UPPER KNIFE CLAMP (FOR 757) 2. KR19 UPPER KNIFE CLAMP (FOR 737,747) 3. SK246 SCREW 4. KR25 WASHER 5. SK277 SCREW</p>		
 <p>KR01 CONNECTION</p>	 <p>FOR 737,747 KR27 LOWER KNIFE HOLDER</p>	 <p>FOR 757 1. KR26 LOWER KNIFE HOLDER 2. SK258 SCREW 3. KR29 GUIDE 4. KR36 CLAMP 5. SK261 SCREW 6. KQ35 WASHER 7. SK256 SCREW</p>	 <p>1. KS02D PRESSER ARM HINGE 2. SK216 SCREW</p>	

高林

YAO HAN INDUSTRIES CO.,LTD.







PARTS FOR SIRUBA 737F,747F,757F

 <p>1. KS01 PRESSER ARM 2. KS03 PIN 3. KS24 CHAIN CUTTER 4. SK357 SCREW</p>		 <p>KS09 FOOT LIFT SHAFT</p>	<p>FOR 737,747</p>  <p>1. KS54 STOPPER 2. SK219 SCREW</p>	
<p>FOR 737,747</p>  <p>1. KS56 PRESSER FOOT HOLDER 2. SK230 SCREW</p>	 <p>1. KS29 HAND LIFT LEVER 2. SP04 HINGE PIN 3. KS31E BUSHING 4. SK213 SCREW 5. KS34 SPRING 6. KS30D PLUNGER</p>	 <p>1. KS28 THUMB SCREW 2. KS27 SPRING 3. KS26-2D PRESSER ARM GUIDE</p>		
 <p>KT14 OIL FILTER</p>	 <p>KT24 OIL SPLASH JOINT</p>	 <p>KT52B GASKET</p>	 <p>1. 4KU27 (FOR 747) ADJUSTABLE SWING EDGE GUIDE ASM. 2. 5KU27 (FOR 757) ADJUSTABLE SWING EDGE GUIDE ASM. 3. AKU27 COLTH GUIDE BRACKET ASM. 4. KU40 EDGE GUIDE (FOR 747) 5. KU39 EDGE GUIDE (FOR 757)</p>	
 <p>KR23 UPPER KNIFE</p>	 <p>KR23A UPPER KNIFE</p>	 <p>KR23C UPPER KNIFE</p>		
 <p>KR35 LOWER KNIFE</p>	 <p>KR35C LOWER KNIFE</p>	 <p>EC02 MOVABLE BLADE</p>	 <p>EC05 FIXED BLADE</p>	
 <p>CT16-1 FIXED BLADE</p>	 <p>CT19 MOVABLE BLADE</p>	 <p>VT04 FIXED BLADE</p>	 <p>VT05 MOVABLE BLADE</p>	 <p>LP22 LP24 LP26 LP28 UPPER LOOPER</p>
 <p>LP21 LP23 LP29 UPPER SPREADER</p>	 <p>LP38 UPPER LOOPER</p>	 <p>LP34 LP36 UPPER LOOPER</p>	 <p>KL25 KL35 LOWER LOOPER</p>	 <p>KM04 CHAIN LOOPER</p>

高林針位組

YAO HAN INDUSTRIES CO.,LTD.

GAUGE SET FOR "SIRUBA" MACHINES

GAUGE SET	size	Throat Plate	Diff Feed Dog	Main Feed Dog	Needle Clamp	Presser foot asm.
C007E-						
	mm					
W122/CH W122/CH/UTP(UTR)	240	E3524P	H4258	D4206	M4240	P0024
	248	E3525P			M4248	P0025
	256	E3826S			M4356	P0216
	356	E3826P			M4356	P0216
	364	E3827P	H4259	D4207	M4364	P0217
U122/CH U122/CH/UTQ(UTS)	240	E3524P	H4258	D4206	M4240	P0314
	248	E3525P			M4248	P0315
	256	E3826S			M4356	P0416
	356	E3826P			M4356	P0416
	364	E3827P	H4259	D4207	M4364	P0417
W132/CHE W132/CHE/UTP(UTR)	240	E2326	H2219	D2109	M4240	P2906
	248	E2327			M4248	P2907
	356	E2326	H2220	D2110	M4356	P2906
	364	E2327			M4364	P2907
W152/CZ/CL/UTP/RLQ U152/CZ/CL/UTQ/RLQ	356	E4326P	H3262	D3216	M4356	P2416
	364	E4327P	H3263	D3217	M4364	P2417
W222/CQ	240	E4124P	H3362	D3216	M4240	P1814
	248	E4125P			M4248	P1815
	356	E4426P			M4356	P2116
	364	E4427P	H3363	D3217	M4364	P2117
U222/CQ	240	E4124P	H3362	D3216	M4240	P2314
	248	E4125P			M4248	P2315
	356	E4426P			M4356	P2616
	364	E4427P	H3363	D3217	M4364	P2617
W322/CC U322/CC W322/CC/UTP(UTR) U322/CC/UTQ(UTS)	356	E2826P	H3259M	D2107L	M4356	P1406
	364	E2827P			M4364	P1407
W322/CD W322/CD/UTP(UTR)	356	E3626P	H4158	D4206	M4356	P1406
	364	E3627P	H4159	D4207	M4364	P1407
U322/CD U322/CD/UTQ(UTS)	356	E3626P	H4158	D4206	M4356	P1606
	364	E3627P	H4159	D4207	M4364	P1607

高林針位組

YAO HAN INDUSTRIES CO.,LTD.

GAUGE SET FOR "SIRUBA" MACHINES

GAUGE SET	size	Throat Plate	Diff Feed Dog	Main Feed Dog	Needle Clamp	Presser foot asm.
C007E-						
	mm					
W322/CE U322/CE	356	E2626P	H3159	D2107	M4356	P1406
	364	E2627P			M4364	P1407
W322/CE/UTP(UTR)	356	E2626P	H3159	D2107	M4356	P1406
	364	E2627P			M4364	P1407
U322/CE/UTQ(UTS)	356	E2626P	H3159	D2107	M4356	P1606
	364	E2627P			M4364	P1607
U322/CF U322/CF/UTQ(UTS)	248	E2625P	H3158	D2106	M4348	P1605
W512/FE(FFC)	240	E3524	H4258	D4206	M4240	P2914
	356	E3826			M4356	P3216
	364	E3827			M4364	P3217
U512/FE(FFC)	240	E3524	H4258	D4206	M4240	P3414
	356	E3826			M4356	P3716
	364	E3827			M4364	P3717
W522/FE(FFC)CRA/CL W522/FE(FFC)CRB/CL U522/FE(FFC)CRA/CL U522/FE(FFC)CRB/CL	356	E6426	H3268	D3222	M4356	P3826
	364	E6427			M4364	P3827
W532/CRA/UTP/CL/RLP/CX U532/CRA/UTQ/CL/RLP/CX	356	E6426	H3268	D3222	M4356	P3816
	364	E6427			M4364	P3817
W542/CF/CFEYCL U542/CF/CFEYCL	240	E2324	H2219	D2109	M4240	P2904
	248	E2325			M4248	P2905
	356	E2326	H2220	D2110	M4356	P2906
	364	E2327			M4364	P2907
W812/CRL/RL W812/CRL/CHP/RL W812/CRL/CHP/UTP/RL W822/CRL/CY/CL/RL W822/CRL/CY/UTP/CL/RL	356	E0226P	H2203	D2101	M4356	P2766
	364	E0227P	H2203	D2101	M4364	P2767
U812/CRL/RL U812/CRL/CHP/RL U812/CRL/CHP/UTQ/RL U822/CRL/CY/CL/RL U822/CRL/CY/UTQ/CL/RL	356	E0226P	H2203	D2101	M4356	P0966
	364	E0227P	H2203	D2101	M4364	P0967

高林針位組

YAO HAN INDUSTRIES CO.,LTD.







GAUGE SET FOR "SIRUBA" MACHINES

GAUGE SET	size	Throat Plate	Diff Feed Dog	Main Feed Dog	Needle Clamp	Presser foot asm.
F007E-						
	mm					
W122 W122/UTG(UTJ)	240	E1524	H1258	D1206	M4240	P0024
	248	E1525			M4248	P0025
	356	E1826	H1259	D1207	M4356	P0216
	364	E1827			M4364	P0217
U122 U122/UTH(UTK)	240	E1524	H1258	D1206	M4240	P0314
	248	E1525			M4248	P0315
	356	E1826	H1259	D1207	M4356	P0416
	364	E1827			M4364	P0417
F007F-U122/FP	232	E1823	H1257	D1206	M4232	P4011
W123 W123/UTG(UTJ)	240	E1534	H1258	D1206	M4240	P0024
	248	E1535			M4248	P0025
	356	E1836	H1259	D1207	M4356	P0216
	364	E1837			M4364	P0217
W162 W162/UTG(UTJ)	356	E1846	H1259	D1207	M4356	P0226
	364	E1847			M4364	P0227
W222/FQ W222/FQ/FE/FAC W222/FFD(FFP)	240	E3024	H1261	D1215	M4240	P1814
	248	E3025			M4248	P1815
	356	E3326	H1262	D1216	M4356	P2116
	364	E3327			M4364	P2117
U222/FQ U222/FFD(FFP)	240	E3024	H1261	D1215	M4240	P2314
	248	E3025			M4248	P2315
	356	E3326	H1262	D1216	M4356	P2616
	364	E3327			M4364	P2617
W222A/FQ/FEC(FAC)	240	E3124	H1261	D1315	M4240	P1914
	248	E3125			M4248	P1915
	356	E3426	H1262	D1316	M4356	P2216
	364	E3427			M4364	P2217
W223	240	E3034	H1261	D1215	M4240	P1814
	356	E3336	H1262	D1216	M4356	P2116
	364	E3337			M4364	P2117
W322/FDC W322/UTG(UTJ)FDC	356	E4826	H1359	D1207	M4356	P1406
	364	E4827			M4364	P1407
U322/FDC U322/UTH(UTK)FDC	356	E4826	H1359	D1207	M4356	P1606
	364	E4827			M4364	P1607
W322/FDE W322/UTG(UTJ)FDE	356	E4836M	H1459	D1207	M4356	P2406
	364	E4837M			M4364	P2407

高林針位組

YAO HAN INDUSTRIES CO.,LTD.

GAUGE SET FOR "SIRUBA" MACHINES

GAUGE SET	size	Throat Plate	Diff Feed Dog	Main Feed Dog	Needle Clamp	Presser foot asm.
F007E-						
	mm					
U322/FDE U322/UTH(UTIQ/FDE)	356	E4836M	H1459	D1207	M4356	P2606
	364	E4837M			M4364	P2607
W512/FE(FFC)	240	E1524	H1258	D1206	M4240	P2914
	248	E1525			M4248	P2915
	356	E1826	H1259	D1207	M4356	P3216
	364	E1827			M4364	P3217
U512/FE(FFC)	240	E1524	H1258	D1206	M4240	P3414
	248	E1525			M4248	P3415
	356	E1826	H1259	D1207	M4356	P3716
	364	E1827			M4364	P3717
W522/FE(FFC)FR	240	E6024	H2267	D2221	M4240	P2814
	248	E6025			M4248	P2815
	356	E6326	H2268	D2222	M4356	P3116
	364	E6327			M4364	P3117
U522/FE(FFC)FR	240	E6024	H2267	D2221	M4240	P3314
	248	E6025			M4248	P3315
	356	E6326	H2268	D2222	M4356	P3616
	364	E6327			M4364	P3617
U612/FBP	200	E1826	H1259	D1207	M4356	P4000
	264	E1827			M4364	P4001
U612/FBQ	256	E1826	H5001	D5001	M4356	P4000
		E4001				P4002
	264	E1827			M4364	P4001
		E4001			P4002	
U613/FBP	256	E1836L	H1259	D1207	M4356	P4000
	264	E1837L			M4364	P4001
U613/FBQ	256	E1836L	H5001	D5001	M4356	P4000
		E4001				P4002
	264	E1837L			M4364	P4001
		E4001			P4002	
U712	264	E5827	H5259	D5207	M5264	P4117
U712/FSP	264	E5827	H5259	D5207	M5264	P5117
U712/FSR	264	E5927	H5359	D5307	M5264	P4217
W722/FY	368	E6828	H6259	D6207	M4368	P6117
W922/FW(FWP)	460	E1828	H1259	D1207	M4460	P2408